

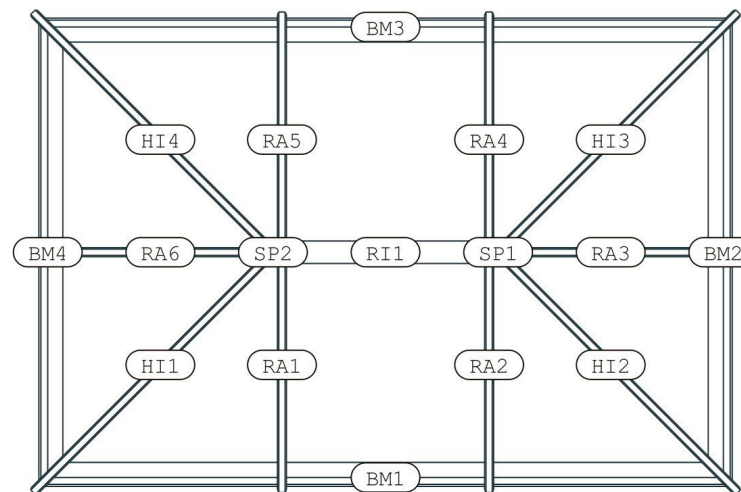



SARIS-EXTENSIONS LANTERN

INSTALLATION GUIDE

LANTERN ILLUSTRATION

To help with installation, the main lantern components have been numbered and lettered. These correspond with the drawings found in your kit instructions, and will look like the image below. Please take care to follow the image in your kit, not the image below.



Screw Description	Location
 REF 4.2 x 45mm	Screws for fixing pressure plates
 REF 4.2 x 25mm	Screws are fixed through the ringbeam to join the ringbeams together at the corners
 REF 4.8 x 50mm	Screws to fix the bottom of transom rafters to the ringbeam
 REF 4.2 x 25mm	Screws to fix bottom of hip rafters



WELCOME TO THE INSTALLATION GUIDE

This installation guide will ensure the quick and easy assembly of your Atlas lantern. It takes you through each stage of installation step by step, with sections on general installation, roof vent installation, bell rafter installation and hidden tie bar installation.

We recommend you spend a little time reading through this guide before you start, to give you an understanding of the roof structure, then follow each step carefully to avoid complications later.

TOOLS YOU'LL NEED:

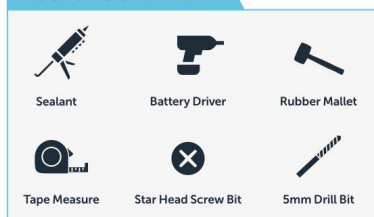

FIXED PITCH INSTRUCTION DETAIL

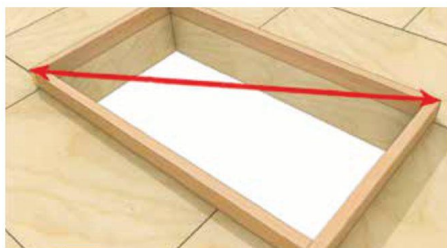

1 Ensure that the kerb upstand by others is square by checking the diagonals.

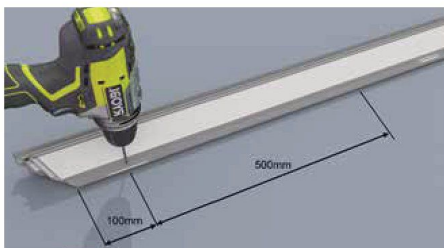

2 Pre-drill the ringbeam as shown, 100mm from the corners and then at 500mm centres.

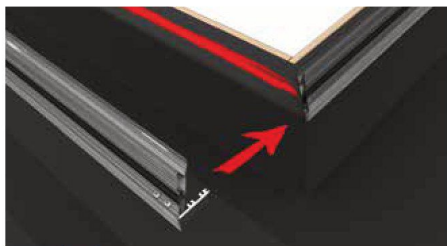

3 Apply a generous bead of sealant to the top of the kerb upstand.

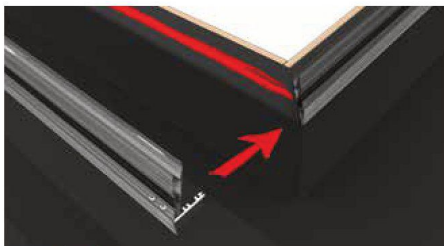

4 Lay the ringbeam out in accordance with the lengths of the kerb upstand and locate the adjacent cleat into the mating ringbeam. Apply sealant to the cut ends of the ringbeam.



5 Using the 4.2 x 25mm screws provided, screw through the pre-drilled holes into the cleat to secure.

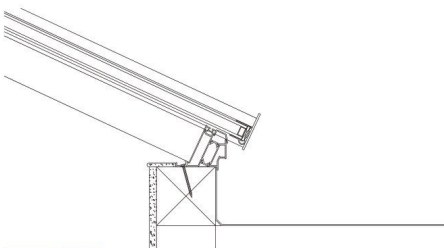

6 Fix down the ringbeam through the pre-drilled holes using an appropriate fixing (recommended minimum of Ø6mm x 50mm).
Note: fixing screws not provided

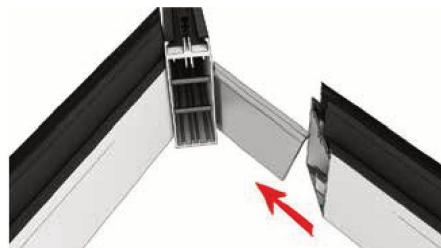

7 Slide the hip rafters over the pre-fitted hip brackets as shown. If a central bell rafter is specified, hip brackets will not be installed and instead the ridge will be slotted. See 'Bell rafter installation' prior to continuing.

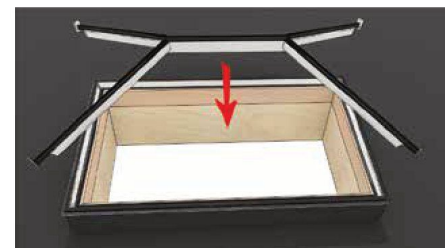

8 Position assembled frame onto ringbeam, pushing the hips down into place.



9 Push the joint tight against the ridge and fix down through the rafter with the supplied screw approximately 25mm from the top with a 4.2 x 25mm screw. Repeat on the opposite side.



10 Fix hips into the ringbeam using the 4.2 x 25mm screws on either side of the rafter as shown.

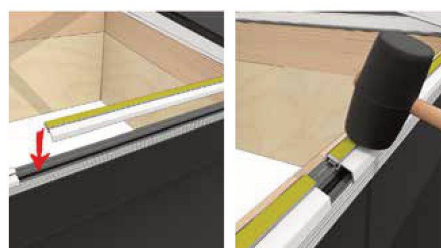

11 Fit supplied glazing support trim. If central transom rafters are specified, push the trim up against the hip which will set the position of the transom.

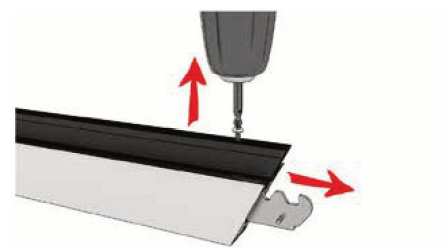

12 Slightly unscrew the fixing in the transom rafter to release the connection bracket.

FIXED PITCH INSTRUCTION DETAIL

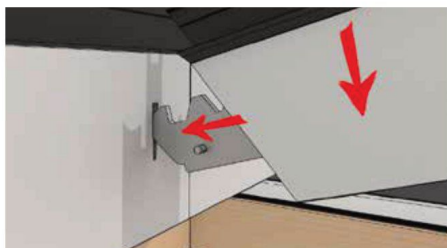

13 Lift transom rafter and offer the bracket up to the slot in the ridge at an angle. Insert the bracket and then rotate the rafter into position at the ringbeam.



14 Re-tighten the screw in the top of the transom rafter which will pull the joint together and secure.



19 Fit glazing around the roof following the roof plan and sit against the lower endcaps. If a roof vent has been specified, follow roof vent installation. Apply pressure to the adhesive of the glazing tape to secure the glass.



20 Fit the ridge pressure plate by centralising on the ridge and then screwing down using the 4.2 x 45mm screws through the pre-drilled holes.



15 Check that the rafter is square to the ringbeam. Fix the 4.8 x 50mm screw supplied centrally through the bottom of the transom rafter as shown to secure the rafter.

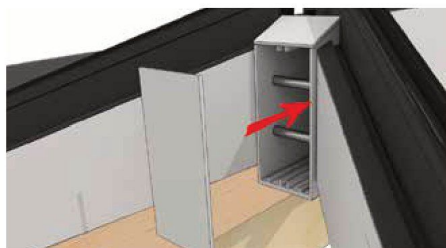

16 Using a small bead of sealant, apply to the rear of the ridge end closer plate and secure to the cut end of the ridge as shown.

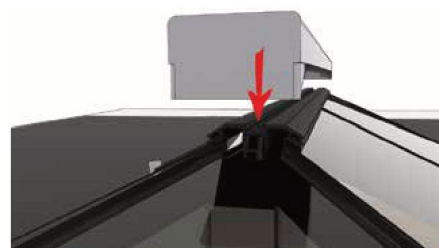

21 Fit the ridge top cap in place by centralising and applying pressure from one end to the other. A rubber mallet may be required.

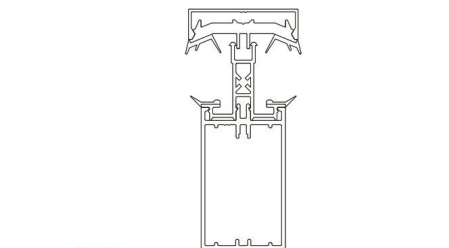

22 Fit hip and transom pressure plates by centralising, they will locate into the central channel on the rafter. Ensure that pressure plates are pushed up against the side of the ridge topcap.

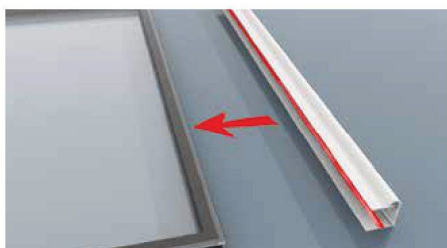

17 Apply a bead of sealant to glazing end closer and fit centrally to glass units.

Note: Always use the correct polymer sealant for self cleaning glass. Illustration shows underside of glass, please note, when fitting drip faces down.

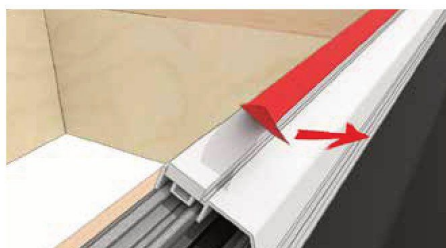

18 Peel back the corner of the glazing tape and remove.

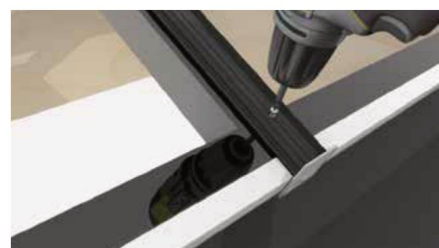

23 Screw down into the rafter through the pre-drilled holes in the pressure plates using the 4.2 x 45mm screws. Repeat for all the rafters.

Note: Drill an additional 5mm hole and add a pressure plate screw. Always add a pressure plate screw through the pressure plate in line with the double-sided tape to help compress the glass to the tape.

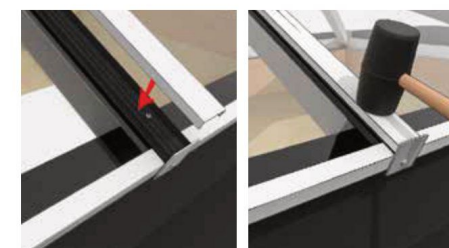

24 Fit all the rafter topcaps according to the correct cut length and roof plan position. Locate over the top of the pressure plate and push down. A rubber mallet may be required.

ADJUSTABLE RINGBEAM INSTRUCTION DETAIL

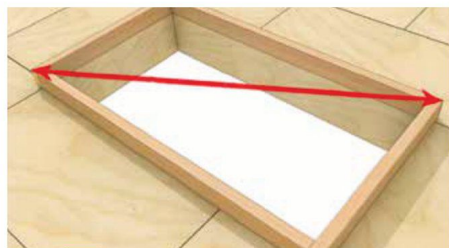

1 Ensure that the kerb upstand by others is square by checking the diagonals.

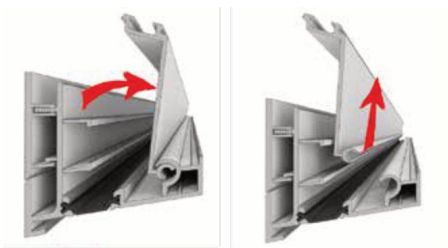

2 Remove ringbeam flap from ringbeam.



7 Insert ringbeam flaps by locating hinge part of the flap into the main ringbeam at approx 80 degrees as shown, then rotate forward to lock in.

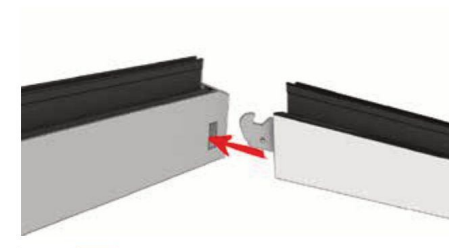

8 Loosen pre-fixed top bracket screw and slide hip rafter and top bracket into slot provided in the ridge body.

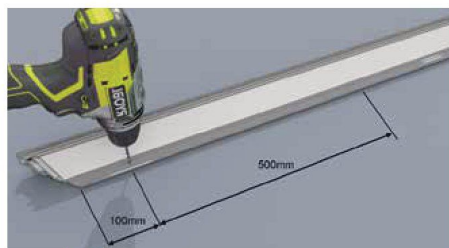

3 Pre-drill the ringbeam as shown, 100mm from the corners and then at 500mm centres.

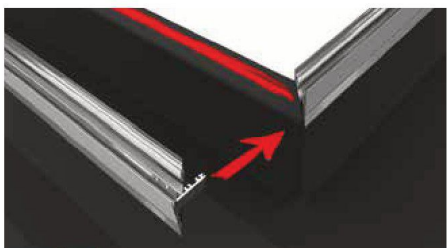

4 Lay the ringbeam out in accordance with the lengths of the kerb upstand and locate the adjacent cleat into the mating ringbeam. Apply sealant to the cut ends of the ringbeam.

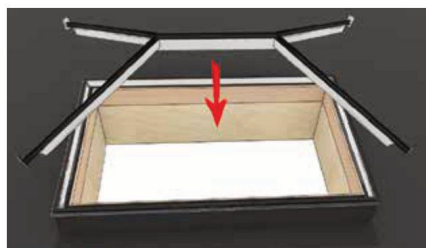

9 Position assembled frame onto ringbeam, pushing the hips down into place.



10 Tighten pre-fixed screw at the top of the hip rafter to hold bracket.



5 Using the 4.2 x 25mm screws provided, screw through the pre-drilled holes into the cleat to secure.

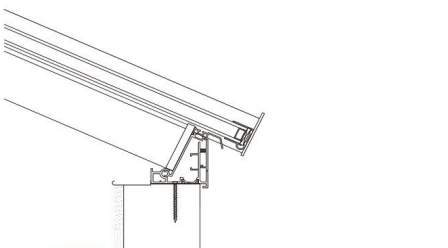

6 Fix down the ringbeam through the pre-drilled holes using an appropriate fixing (recommended minimum of Ø6mm x 50mm).
Note: fixing screws not provided

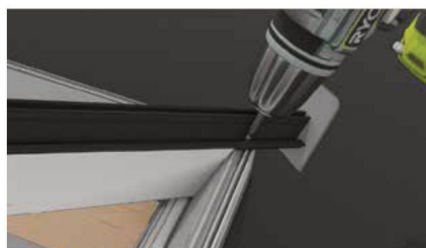

11 Fix hips into the ringbeam using the 4.2 x 25mm screws on either side of the rafter as shown.

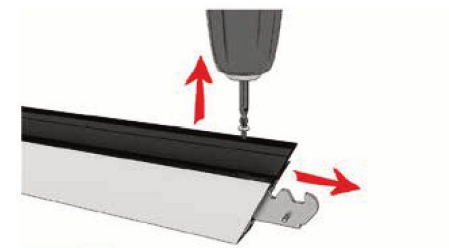

12 Slightly unscrew the fixing in the transom rafter or jack rafter to release the connection bracket.

ADJUSTABLE RINGBEAM INSTRUCTION DETAIL

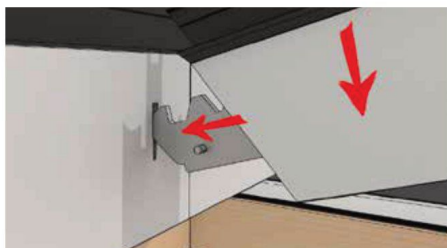

13 Lift transom rafter or jack rafter and offer the bracket up to the slot in the ridge or hip at an angle. Insert the bracket and then rotate the rafter into position at the ringbeam.



14 Use internal foamboards to space out rafter positions before fixing rafters to the ringbeam.



19 Fit glazing around the roof following the roof plan and sit against the lower endcaps. If a roof vent has been specified, follow roof vent installation. Apply pressure to the adhesive of the glazing tape to secure the glass.



20 Fit the ridge pressure plate by centralising on the ridge and then screwing down using the 4.2 x 45mm screws through the pre-drilled holes.

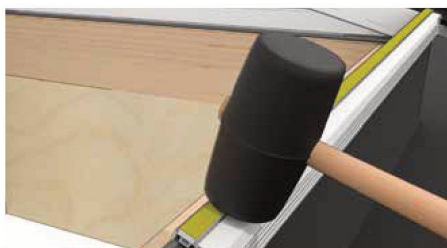

15 Fit supplied glazing support trim between rafters and tap on with a rubber mallet, then silicone foamboards to the ringbeam flap between the rafters.

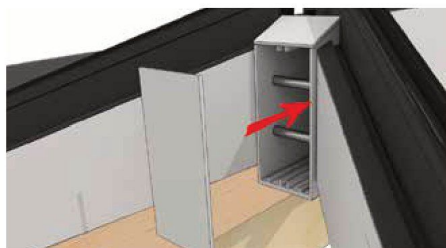

16 Using a small bead of sealant, apply to the rear of the ridge end closer plate and secure to the cut end of the ridge as shown.

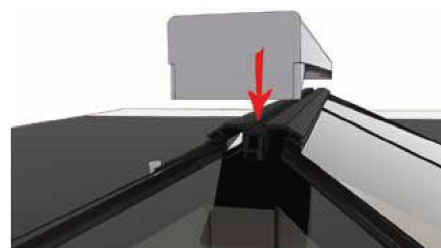

21 Fit the ridge top cap in place by centralising and applying pressure from one end to the other. A rubber mallet may be required.

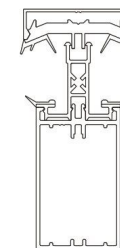

22 Fit hip and transom pressure plates by centralising, they will locate into the central channel on the rafter. Ensure that pressure plates are pushed up against the side of the ridge topcap.

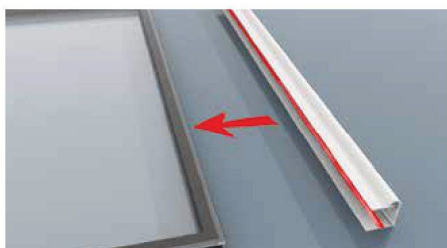

17 Apply a bead of sealant to glazing end closer and fit centrally to glass units.

Note: Always use the correct polymer sealant for self cleaning glass. Illustration shows underside of glass, please note, when fitting drip faces down.

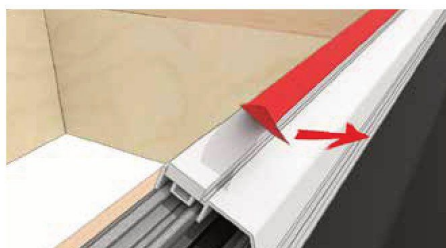

18 Peel back the corner of the glazing tape and remove.



23 Screw down into the rafter through the pre-drilled holes in the pressure plates using the 4.2 x 45mm screws. Repeat for all the rafters.

Note: Drill an additional 5mm hole and add a pressure plate screw. Always add a pressure plate screw through the pressure plate in line with the double-sided tape to help compress the glass to the tape.

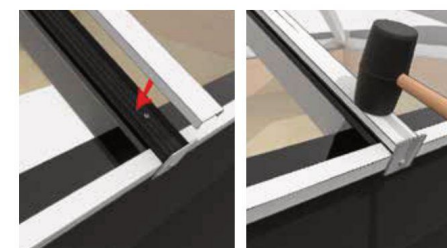

24 Fit all the rafter topcaps according to the correct cut length and roof plan position. Locate over the top of the pressure plate and push down. A rubber mallet may be required.

HIDDEN TIE BAR INSTRUCTION

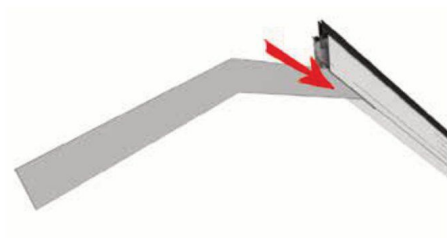

1 Insert tie bar bracket into the side of one of the central rafters.



2 Loosen retaining screw from transom connection bracket so that it can move freely and insert transom bracket into slot in the ridge.

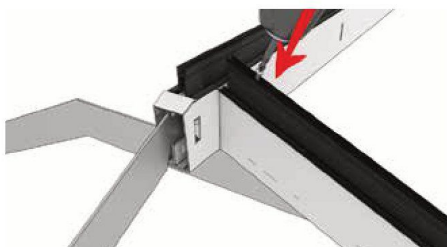

3 Re-tighten bracket retention screw to pull the joint tight.

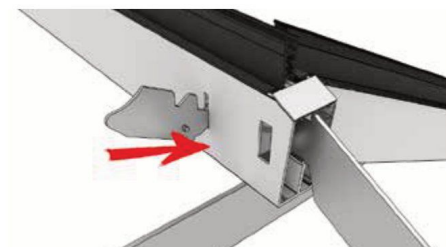

4 Insert the transom connection bracket into the slot in the opposite side of the ridge.

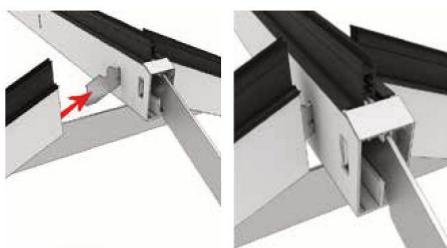

5 Slide the opposite transom rafter over the bracket and push against the ridge.



6 Secure with the retention screw as per the opposite side.

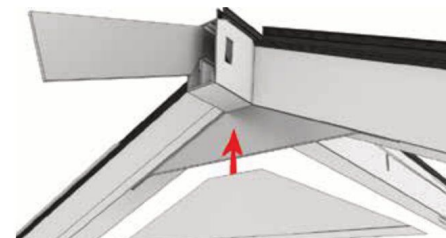

7 Locate the gusset plate over the tie bar.



8 Secure in pre-drilled holes with supplied 5 x 70mm screws and fit cap covers.

BELL RAFTER INSTALLATION

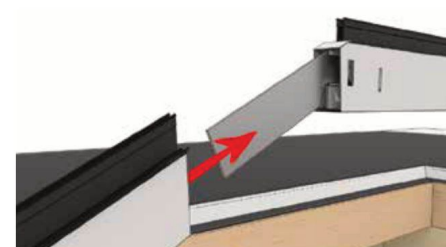

1 Slide central bell rafter over the factory-fitted bracket.

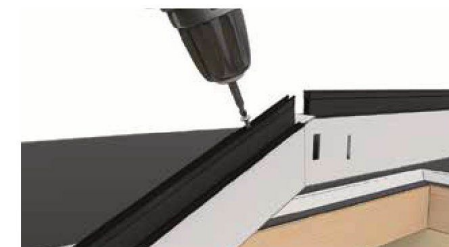

2 Secure the bell rafter using the pre-fitted retention screw.



3 Loosen retention screws in hips and insert the connection brackets into the wider machined slots in the side of the ridge. Return to step 8, fitting the framework into the ringbeam, pushing down the hips to tighten the joints. Tighten retention screws.

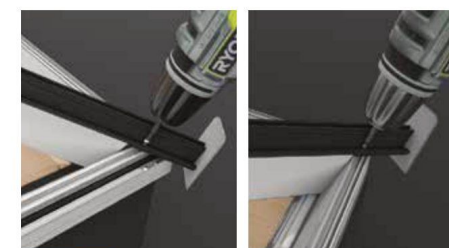

4 Fix hips into ringbeam using the provided 4.2 x 25mm fixings on either side of the rafter as shown.

ROOF VENT INSTALLATION

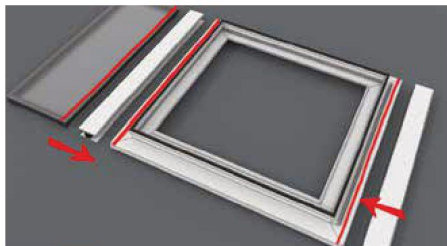

1 Apply sealant to upper face of both the glazed unit and vent and assemble to the muntin profiles as shown.

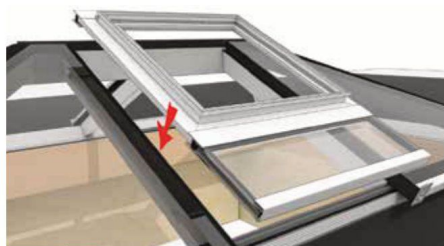

2 Install the assembled vent base and glazed units between the transom rafters behind the rafter endcaps.

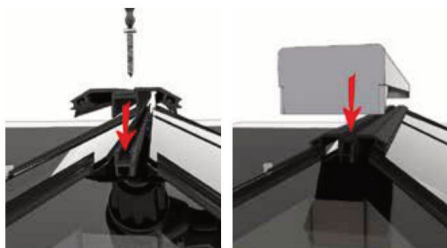

3 Fit ridge pressure plate and topcap.

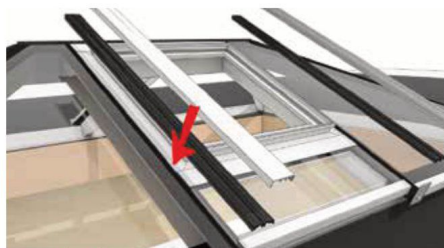

4 Fit transom pressure plates, screwing into place through the pre-drilled holes. Fit rafter topcaps.

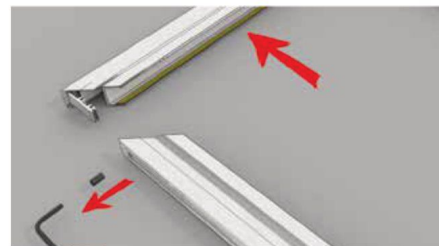

5 Remove grub screws from the sides of the vent sash and remove one side as shown.

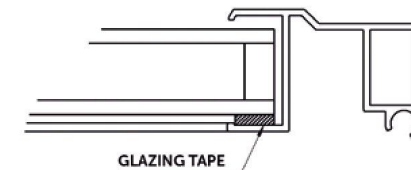

6 Remove protective film from the glazing tape on the sash profile.

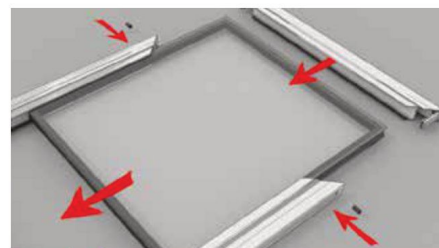

7 Fit glazed unit into the sash frame and re-fit the removed side of the sash framework, securing with the grub screws.

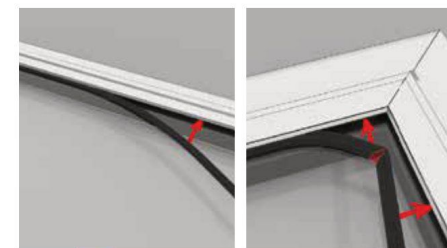

8 Starting from a corner, apply the wedge gasket to the opposite side of the vent sash (to the glazing tape), notching the corners to allow the gasket to fit tight into the corners of the framework.

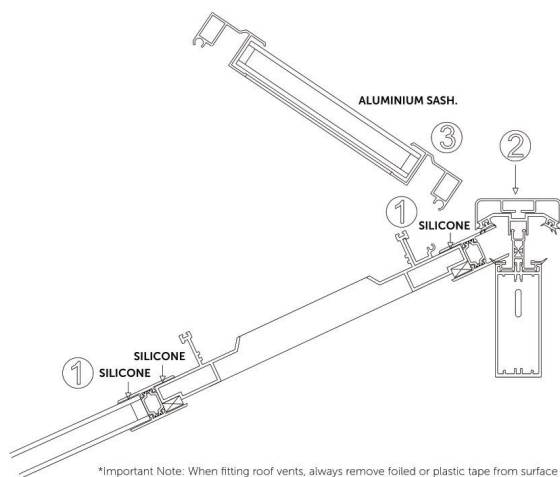

*Important Note: When fitting roof vents, always remove foiled or plastic tape from surface of units before sealing. Always use the correct polymer sealant for self-cleaning glass.

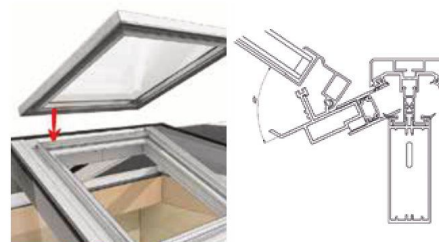

9 Fit vent sash to the vent base by locating the channel in the sash profile into the 2 pivot profiles on either end of the vent base as shown. The sash should be offered at approximately 60° to engage correctly, then rotated down to lock in.

10 Locate and install the spindle or actuator, securing in place with the supplied fixings.

BOX TIE BAR INSTRUCTION

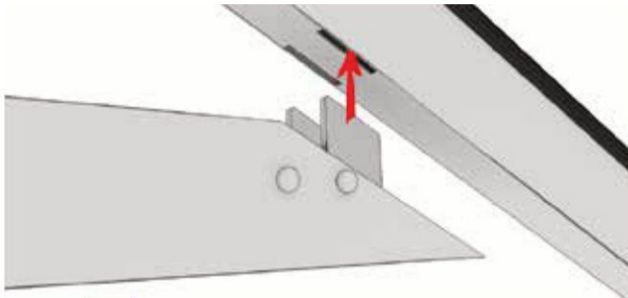

1 Fit the tie bar into slots on the underside of rafters.



2 Fix tie bar to rafter by screwing through pre drilled hole in the bottom of the tie bar.



3 Using a 6mm bit, drill a hole through the rafter and tie bar brackets.

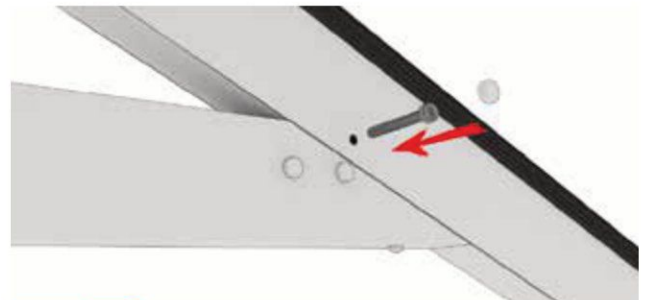

4 Push the 6mm x 45mm bolt with caps through the bar and tie bar brackets.

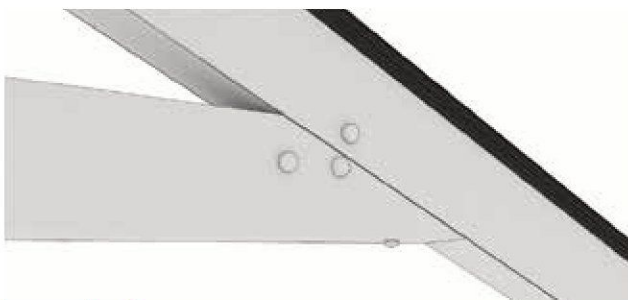

5 Clip on finishing D caps to complete A frame.

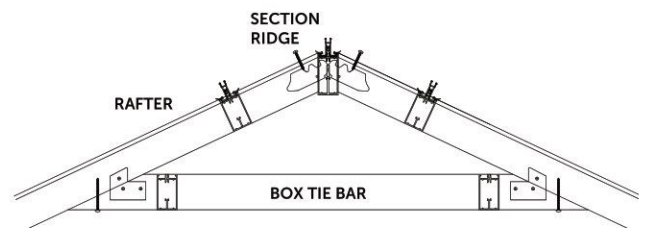

6 Section drawing.

The information provided in this publication is provided "as is" on June 2022. Atlas Roofing may modify and change the information and specifications from time to time for a variety of reasons, without prior notice and updates will not be issued automatically. This information is not intended to have any legal effect, whether by the way of advice, representation or warranty (express or implied). All rights reserved. Copyright in this publication belongs to Atlas Roofing and all such copyright may not be used, sold, copied or reproduced in whole or part in any manner in any media to any person without prior consent. Copyright © 2022 Atlas Roofing. All rights reserved.

Email: support@saris-extensions.co.uk

Phone: 02081245500

Phone: 07498453303